

# RUBBERIZED MAGNETIC SYSTEM

30177520

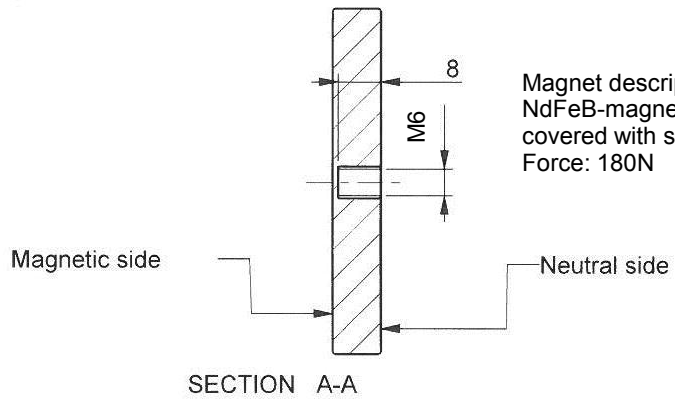

Magnet description:  
NdFeB-magnets placed on pole plate,  
covered with synth. rubber.  
Force: 180N

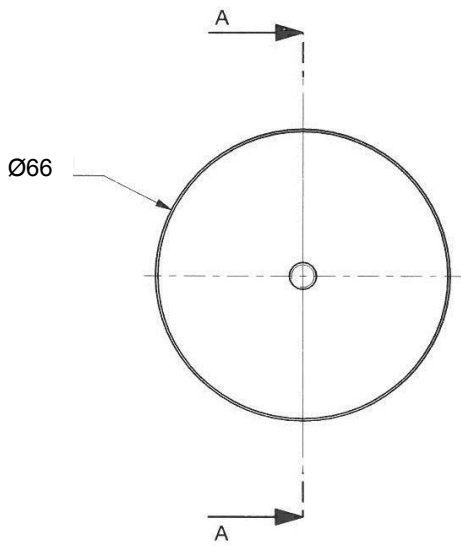
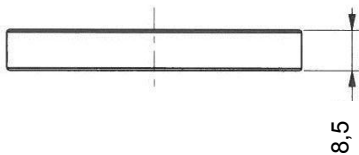

**Diesella**

Diesella A/S | Marsvej 20 | DK-6000 Kolding  
Tel. +45 7633 8888 | Fax +45 7633 8899 | info@diesella.dk | diesella.dk