

USERS MANUAL

NON-CONTACT INFRARED THERMOMETER

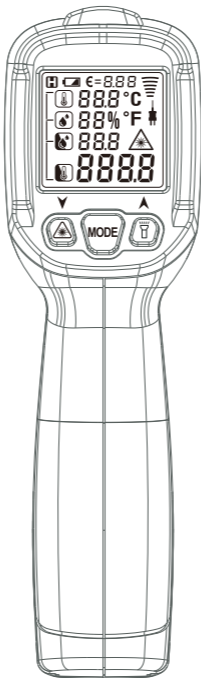

CE



Before using the instrument, please read this manual carefully, and save it well for future using.

1. Safety information

- Please read carefully the Operation Manual before operating the instrument
- Don't cleanse the temperature measuring instrument with any solvent
- Safety symbols



Important notices against hazards



Compliant with European CE safety directive

This instrument complies with the standards provided below:

- EN61326-1
- EN60825-1

Warning!

Laser must be prevented from aligning itself towards human eyes or reflective surfaces.

2. Important notices

- When the working environment experiences a sudden change, the temperature measurement meter must be placed in an environment for 30 minutes. The measurement can be resumed only when the temperature inside the meter is consistent with that outside it.
- The electromagnetic field from electric welding and inductive heating must be minimized.

- Don't put the temperature measurement meter close to or onto a hot object.
- The meter must be kept clean so that dust is denied access to lens cone.

3. Physical appearance

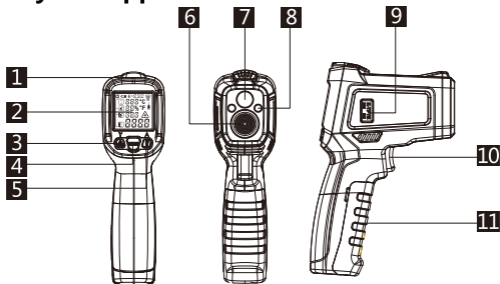

- ① Alarm indicator
- ② LCD screen
- ③ Laser control key/numeric adjustment key ▼
- ④ Mode key
- ⑤ UVlight control key/numeric adjustment key ▲
- ⑥ Infrared sensor's sensing area
- ⑦ Laser indicator
- ⑧ UV light
- ⑨ K type thermocouple socket
- ⑩ Measurement trigger
- ⑪ Battery cover

4. LCD screen

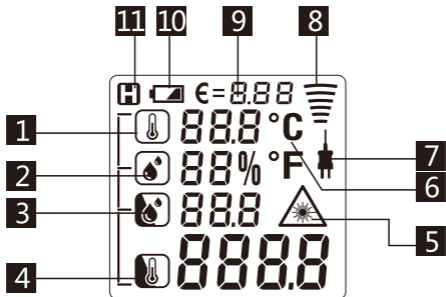

- 1** Ambient temperature: the currently measured ambient temperature.
- 2** Ambient humidity: the currently measured humidity.
- 3** Dew point temperature: the currently measured dew point temperature.
- 4** Surface temperature: the currently measured non-contact temperature.
- 5** Laser enabling indication
- 6** Temperature unit
- 7** K thermocouple temperature measurement
- 8** Measurement indication
- 9** Emissivity
- 10** Battery under-voltage alarm
- 11** Data hold

5. Measurement method

1. Mildew alarm mode

Press Mode key to switch to mildew alarm mode; press the trigger and the instrument will display current ambient temperature, humidity, dew point and surface temperature. The instrument will judge whether the object measured suffers mildew or not according to the difference between the surface temperature of the object to be measured and the dew point temperature in current ambient environment. When the object measured is free of mildew, the yellow indicator of the instrument will be on. When the object has suffered mildew, the red indicator will be on. When the object shows a sign of mildew, the yellow indicator will be on.

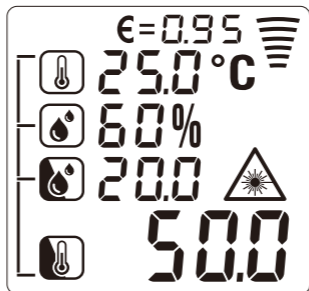

2. Temperature difference alarm mode

Press Mode key to switch to temperature difference alarm mode; press the trigger and the instrument will display the currently measured ambient environment and surface temperature. The instrument will judge whether the object measured works normally or abnormally according to the difference between the surface temperature of the object to be measured and the current ambient environment. When the temperature of the object measured is close to ambient temperature, the instrument's green indicator will be on. When the temperature of the object measured is much higher or lower than ambient temperature, the instrument's red indicator will be on; otherwise the yellow indicator will be on.

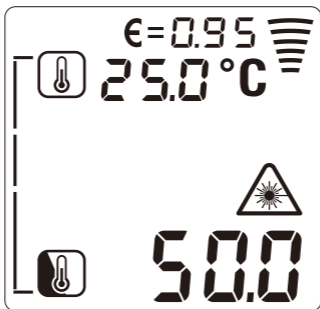

3. K type thermocouple temperature measurement

Press MODE key to switch to K type thermocouple temperature measurement mode. Then the instrument will display this symbol . Insert K type thermocouple probe into the instrument's thermocouple socket; press the trigger key and the instrument will simultaneously display the values of both K type temperature and surface temperature.

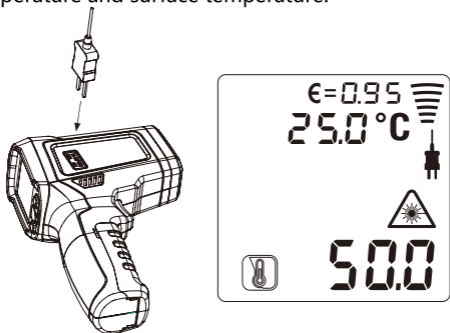

4. Set the emissivity for the instrument

Press Mode key to set the instrument's emissivity. The instrument's status is shown in the diagram below. Press $\blacktriangle/\blacktriangledown$ key to increase or decrease emissivity value. A long press on the $\blacktriangle/\blacktriangledown$ key will mean rapid increase or decrease in the set value.

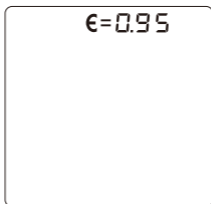

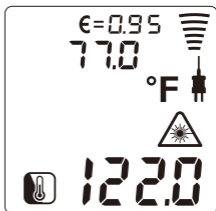
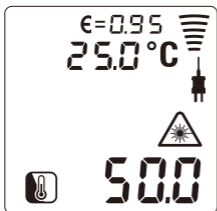

5. Set the temperature unit for the instrument

Press the Mode key for 2 seconds to switch the temperature measurement unit.



6. Enable/disable laser

Press  key to enable or disable laser. The instrument will display the symbol  for laser.

7. Turn on or off UV light(Leak detection)

Press  key to turn on or off UV Light.

Leak detection:

The leakage of vehicle air conditioning and other high pressure systems can be detected quickly by

ultraviolet. Fluorescent agent is injected into the air conditioning system, fluorescent agent will with the refrigerant in the air-conditioning system in circulation, when the air conditioning system has a leak, fluorescent agent will left the leakage. Fluorescence leakage under the irradiation of ultraviolet light can emit fluorescence at, and then find the leak.

6. Proportion between the distance from probe to object and the diameter of the object to be measured (D:S)

Temperature measurement meter has a certain angle and field of vision, as shown in the diagram below:

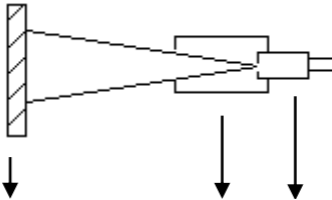

The object to be measured

lens

photosensitive element

It must be ensured that the object to be measured is fully within the field of vision afforded by the temperature measurement meter, that is, the meter

can see nothing but the object to be measured. The greater the object to be measured is, the farther the distance detected by the meter may be. The smaller the object is, the shorter the distance to be measured must be. The proportion between the distance to be measured and the size of the object to be measured (D:S) is 12: 1, as shown in the diagram below:

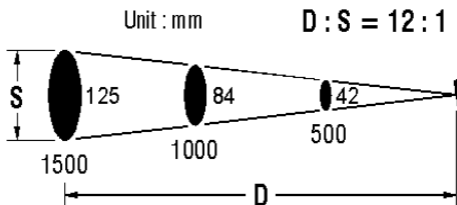

While measuring an object, the instrument will emit an indicative ring. The measured temperature of the surface is the internal temperature of the ring.

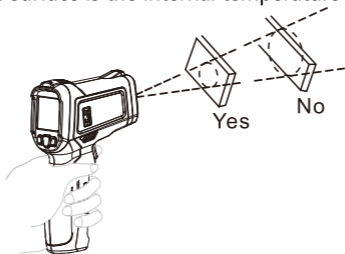

7. Emissivity

Emissivity refers to the ability of an object to emit infrared ray. The greater the emissivity is, the stronger the emission ability of the surface of an object is. The emissivity of most organic substances or oxidized surfaces of metals falls within the range of 0.85~0.98. The default emissivity of this measurement device is 0.95. The instrument's emissivity is set to be consistent with that of the object to be measured at the moment of measurement. The effect of emissivity on measurement result must be noticed at the time of measurement.

The diagram provided below is a reference table for emissivity.

Table 2 Surface emissivity

Surface measured		Emissivity
Aluminum Metal	Oxidized	0.2~0.4
	A3003AlloyOxidized	0.3
	A3003AlloyRough	0.1~0.3
Brass	Polished	0.3
	Oxidized	0.5
Copper	Oxidized	0.4~0.8
	Electronic terminal Board	0.6

Hastelloy		0.3~0.8
Chromium -Nickel-Iron Alloy	Oxidized	0.7~0.95
	Sandblast	0.3~0.6
	Electro-Polished	0.15
Iron	Oxidized	0.5~0.9
	Rusted	0.5~0.7
Iron(Cast)	Oxidized	0.6~0.95
	No Oxidized	0.2
	Melt & cast	0.2~0.3
iron(Forged) Passivated		0.9
Lead	Rough	0.4
	Oxidized	0.2~0.6
Mo Oxidized		0.2~0.6
Nickel Oxidized		0.2~0.5
Platinum Black		0.9
Steel	Cold rolled	0.7~0.9
	Sanding plate	0.4~0.6
	Polished plate	0.1
Zinc	Oxidized	0.1
Asbestos		0.95
Asphalt		0.95
Basalt stone		0.7
Carbon		0.8~0.9
non-oxidized		0.7~0.8

Graphite	0.9
Silicon Carbide	0.95
Clay	0.95
Concrete	0.95
Fabric	0.95
Glass plate	0.85
Sand-gravel	0.95
Gypsum	0.8~0.95
Ice	0.98
Limestone	0.98
Paper	0.95
plastic	0.95
Soil	0.9~0.98
Water	0.93
Wood (natural)	0.9~0.95

8. Battery replacement

When the battery's power is low, the battery symbol indicator  will be on. At such moment, you must replace the existing battery. What you need to do is to open the battery cover and replace the old battery with a new 9V battery. Refer to the diagram below:

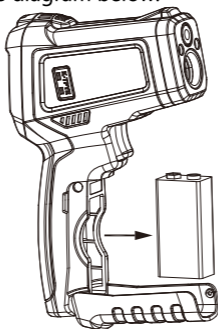

9. Technical parameters

LCD	Color LCD
D:S	12:1
Response spectrum	8~14um
Emissivity	0.10~1.00
Laser	<1mW /630-670nm Level 2
UV Light(BLUE)	✓

Response time	<0.5S
Auto shutdown	15 seconds
Operational temperature	0~40 °C
Storage temperature	-10°C~60°C
Power	9V 6F22 battery
Measurement range (Non-contact temperature measurement)	-50°C~800°C (-58°F~1472°F) -50°C~0°C ±3°C 0~800°C ± (1.5% reading+2°C /4°F)
Ambient temperature	±1.0°C/2°F (0-- 45°C/32--113°F) ± 1.5°C/3 °F (-10--0°C , 45--60°C/14~32°F,113~140°F)
Ambient humidity	±4.0% RH (20% --- 80%) ± 5.0% RH (0% --- 20%; 80% ---100%)
Dew point temperature	-10 - 50°C (14 -122°F) ±1.5°C/3°F
K type temperature measurement	-10°C~537°C (14°F~999°F) ±(1.5% reading+2°C/4°F)

EMC

